

AMPTDBU-0.6/50

DC Motors for Honeycomb Top Down / Bottom Up Shades
 Part # 62009000

dimensions

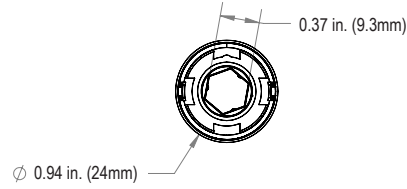
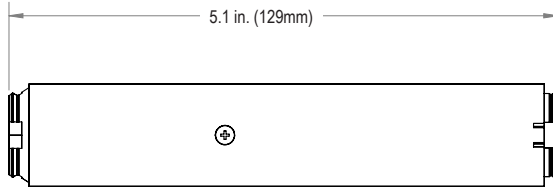

specifications

Model	AMPTDBU-0.6/50
Torque	0.6Nm
Speed	50rpm (adjustable to 34 or 40)
Motor Size (L x W x H)	129mm*24mm*24mm
Voltage	8.4V DC
Current	1A
Power	8.4W
IP Class	IP20
Insulation Grade	A

Battery Model / Type	External Battery Pack (PN: 62203100)
Battery Capacity	3200mAh
Working temp	32°F to 140°F (0°C to 60°C)
RF Modulation	FSK
Radio Frequency	433.92 MHz
Max Running Circles	6 Minutes
Limit Switch Type	Electronic
Sound Level	48dB
Net Weight	0.28Lbs



***All AMP tubular, honeycomb, and tilt motors — with or without an external battery pack — must use a minimum 2A (amp) charger to properly charge the shade. Use of a lower amperage charger may cause improper charging, permanent battery depletion, or motor failure.**

features & applications



external battery pack
inside headrail

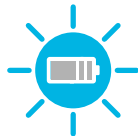

solar charging



bi-directional

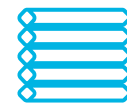

cellular/honeycomb
standard



cellular/honeycomb
tdbu



app compatible

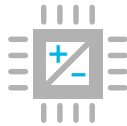

electronic limit



slow jog &
tilt mode

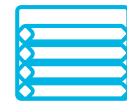

cellular/honeycomb
skylight

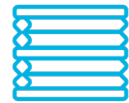

cellular/honeycomb
day/night

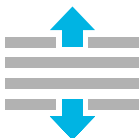

leveling control



favorite position



adjustable RPM



AMPTDBU-0.6/50

DC Motors for Honeycomb Top Down / Bottom Up Shades

Part # 62009000

system overview

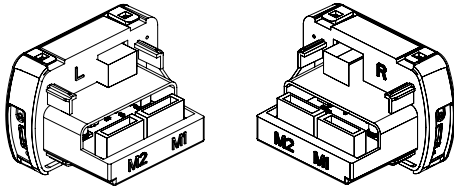

End Cap with RF Controller
Part # 62009100 (RH); 62009200 (LH)

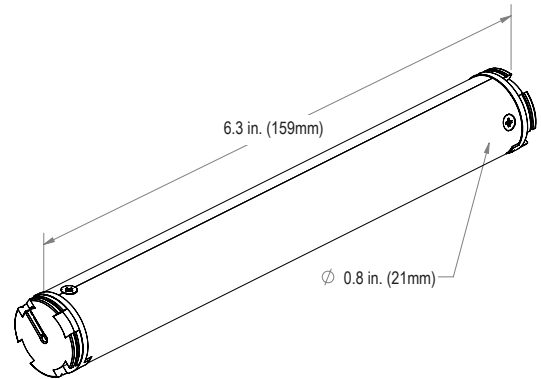

Inside Headrail External Battery Pack
Part # 62203100

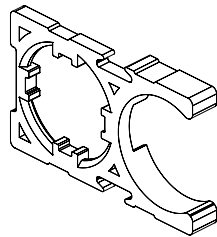

Headrail Adapter
Part # 62321100

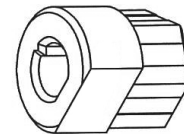

V Rod Adapter
Part # 62322000

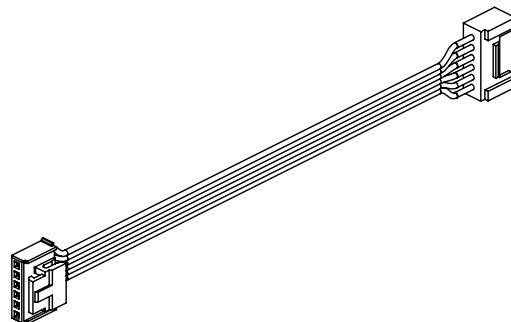

Cables from RF Controller to Motor 1
Part # 62208000 (2.7 in.)



Cables from RF Controller to Motor 2
Part # 62208100 (2.9 ft.); 62208200 (6.5 ft.); 62208300 (12.1 ft.)

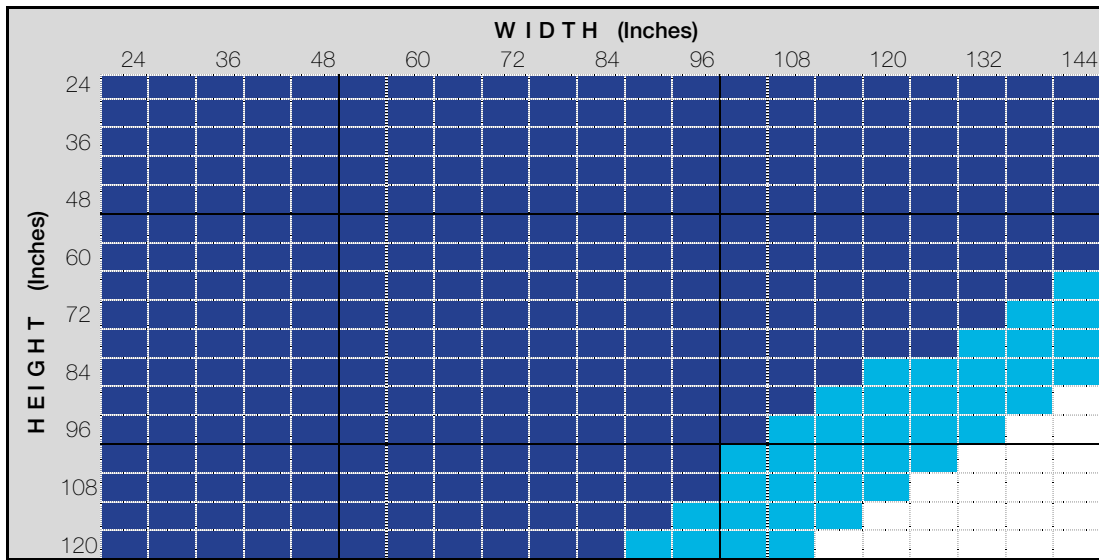

AMPTDBU-0.6/50

DC Motors for Honeycomb Top Down / Bottom Up Shades
Part # 62009000



	Under 80% Load
	Between 80% Load and 100% Load
Fabric:	3/4" Blackout (F17)
Bottom Rail:	3/4" Universal Head/Bottomrail